

1

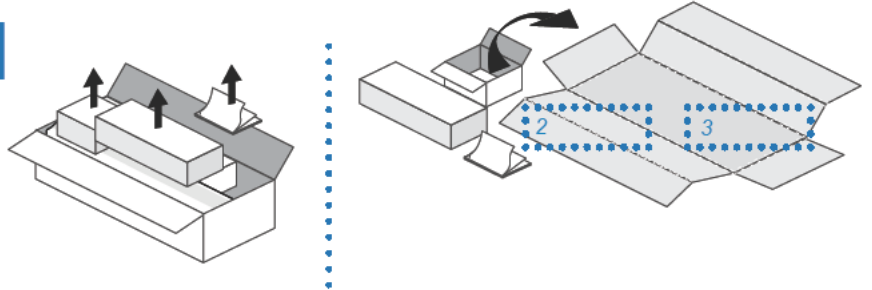

2

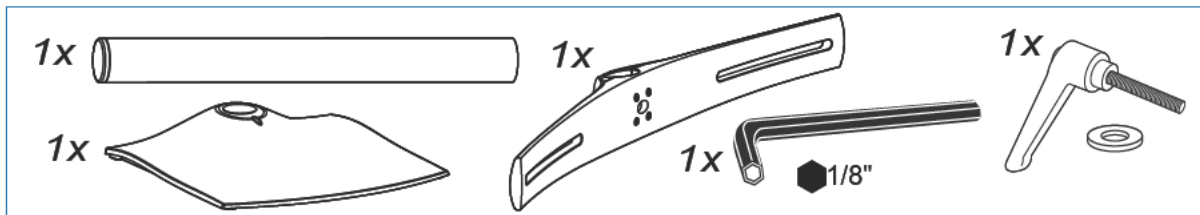

a

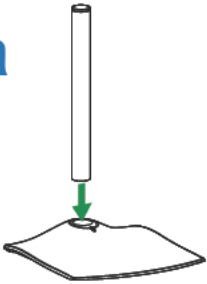

b

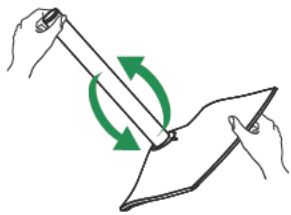

c

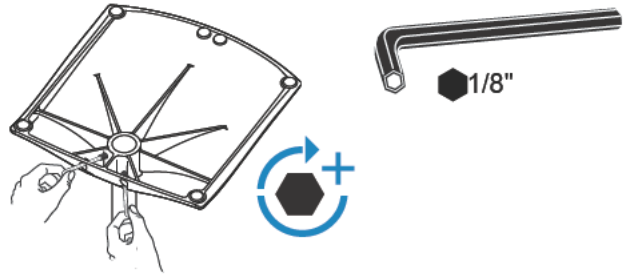

d

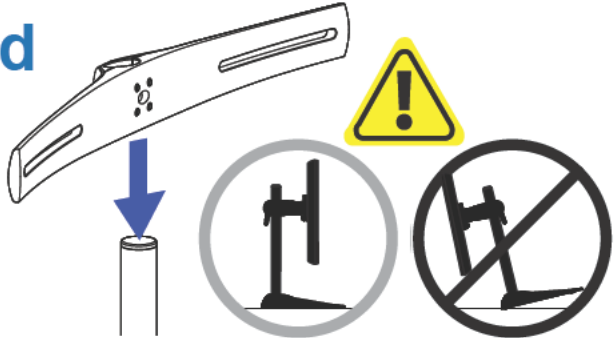

e

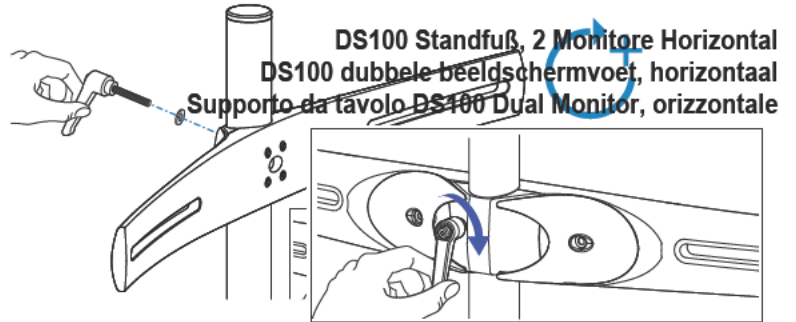

DS100 Standfuß, 2 Monitore Horizontal
DS100 dubbele beeldschermvoet, horizontaal
Supporto da tavolo DS100 Dual Monitor, orizzontale

3

Um den gewünschten Sichteffect zu erreichen, LCDs an den Pivots befestigen, so dass sie sich einander, wenn sie mit dem Bogen verbunden werden, wie in Option 1 horizontal, wie in Option 2 aufwärts oder wie in Option 3 abwärts zuneigen. Dabei muss beachtet werden, dass das breite Ende jedes LCD-Pivots mit einem Pluszeichen (+) und das schmale Ende mit einem Minuszeichen (-) gekennzeichnet ist. Der Größenunterschied ergibt 4° Neigung.

Om het gewenste weergave-effect te verkrijgen dient u de LCD-schermen te bevestigen op spillen, zodat ze, wanneer ze op de boog zijn bevestigd, horizontaal naar elkaar toe kantelen (zoals bij optie 1), omhoog (zoals bij optie 2) of omlaag (zoals bij optie 3). Merk op dat het brede einde van de LCD-spillen voorzien is van een plusteken (+), en het smalle einde is voorzien van een minteken (-); het verschil in grootte komt overeen met 4° kanteling.

Per ottenere l'effetto visivo desiderato, collegare gli LCD ai pivot in modo tale che montati sull'arco si possano inclinare l'uno verso l'altro, orizzontalmente come nella Opzione 1, verso l'alto come nell'Opzione 2, o verso il basso come nell'Opzione 3. Notare che l'estremità larga di ogni pivot per LCD è contrassegnata con un più (+), mentre quella stretta con un meno (-); la differenza in dimensioni è pari a 4° di inclinazione.

